

Article number: 2310301752ESD

Description: E+G Antistatic base for levelling elements
LV.A-80-24-AS-ESD-C

Measures

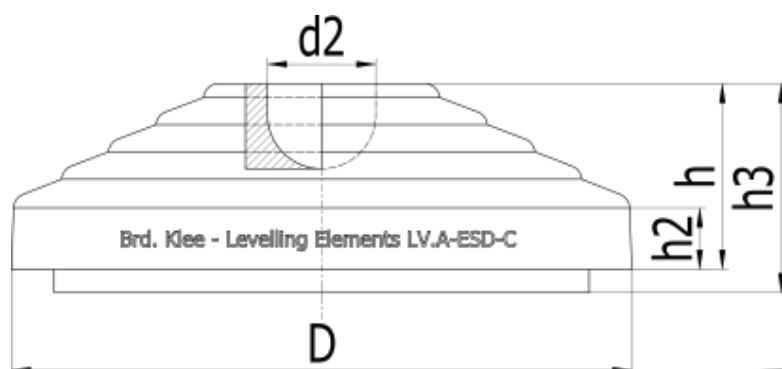

D	= 80
d2	= 24
h	= 24
h2	= 9
h3	= 27
N	= 18000
Weight in g	= 49